

Roxtec BG™



Diverting unwanted currents from your electrical installations

José Claudio de Oliveira e Silva
www.aptemc.com.br

Contents

	Page
Introduction	3
Shielding and cable entrances	4
Lightning	11
Cable bonding efficiency tests	17
Comments on test results	23
Other considerations	26
References	30

Abbreviations

AC	alternating current
AWG	American Wire Gauge
CBN	common bonding network
CDN	coupling/decoupling network
DC	direct current
EFT/B	electrical fast transients/bursts
EMC	electromagnetic compatibility
EMI	electromagnetic interference
EUT	equipment under test
IEC	International Electrotechnical Commission
ITU	International Telecommunication Union
LPL	lightning protection level
LPS	lightning protection system
MET	main earthing terminal
PE	protective earth
PEN	protective earth and neutral
RBS	radio base station
SPD	surge protective devices
SPM	surge protection measures

Introduction

In this article, an important issue of electromagnetic compatibility (EMC) will be discussed: the cable entrances to electrical installations and equipment, and the equipotential bonding¹ of cable shields at these points. In addition to a conceptual introduction to the subject, some interesting and elucidatory test results are also presented.

In section *Shielding and cable entrances*, concepts are presented that lead us to realize the need and importance of cable bonding at the point the cables traverse the walls of a shielded structure or the boundary of an installation, even if not shielded, to prevent or minimize the ingress of electromagnetic disturbances coupled to the cables in the external environment.

In section *Lightning*, a discussion is made about the importance of diverting the lightning currents from and reducing their effects on electrical installations, due to their exceedingly high intensities and induction capacity, which frequently cause damages to electrical equipment.

In the following section, *Cable bonding efficiency tests*, test results are presented about the efficiency of some bonding configurations at the cable entrance of a shielded cabinet. Two of the configurations involve external connections through cables (including pigtails), which are common, and one configuration is based on the sealing and bonding solution of ROXTEC BGTM cable transits.

The ROXTEC BGTM solution was used to demonstrate the high efficiency that can be obtained from a properly made bonding of cables at the cable entrance of a shielded cabinet.

The measured efficiencies belong to the test setups in particular, so it is in fact an evaluation of the total arrangement, where the shielding characteristics of the cabinet, for instance, takes part in the result. The objective is not to evaluate the performance of ROXTEC BGTM as an individual component, but to show that proper bonding of cable shields at the entrance points of shielded structures can result in very effective diversion of unwanted currents brought by the cables.

The tests are based on current impulse measurements. The applied currents are from impulse generators used in electromagnetic immunity tests of products against transient conducted disturbances, namely lightning surges and EFT/B (electrical fast transient/burst). It is therefore a time domain test, mainly intended to provide a visual, more understandable figure about the results and the subject.

Finally, some comments follow the test results and other considerations on the subject are made.

¹ In this article, the term *earthing* is used instead of *grounding*, meaning a connection to earth or to an earthed conductive part of the installation, whichever is the purpose it suits in the context: protective or functional earthing, or both. In most cases, however, the connections treated herein are better defined as *equipotential bonding*, which is an electrical connection between conductive parts, intended to achieve electrical equipotentiality between them, see IEC vocabulary at www.electropedia.org. More specifically, equipotential bonding in this article will involve cable shields and other conductive bodies through which unwanted currents are diverted from the cables, regardless of these bodies being earthed or not. It worth mentioning that, rigorously, the term “equipotential” and others that derive from it, is a concept that only applies to direct current (DC) or, approximately, to low frequency. For high frequency voltages and currents, an equipotential bonding can only be effective if the connection is short and of adequate geometry.

Shielding and cable entrances

When a shielded structure (e.g. enclosure, cabinet, panel, container, room), with no cable passing through its metallic walls, is illuminated by radiated electromagnetic fields, the leakage of fields inside normally occurs through openings for ventilation, displays, door slits etc. Some field may also penetrate by diffusion through the wall, depending on its material, thickness and frequency of the electromagnetic field.

In general, a small hole on the wall of such structures has little effect on its shielding effectiveness. However, a cable passing through the same hole, isolated from the wall, can change the situation completely, causing a significant degradation of the shielding.

When cables carelessly traverse the wall of a shielded structure, the shielding effectiveness is reduced because the electromagnetic disturbances coupled to cables outside are conveyed by the cables to the internal environment, reradiating inside and vice-versa, possibly leading to EMC problems.

Cable entrances in an equipment or installation is almost always unavoidable. To prevent losing the shielding properties of a solidly shielded enclosure due to cables, the cables have to be perfectly bonded to the enclosure wall at the very point they enter the structure, ideally. By perfect bonding, for example, consider that the cable shielding is welded to the enclosure wall through the entire shielding circumference, which is usually referred as a “360° bonding”. Most current, coupled or injected on the cables from an external disturbance source, will “prefer” to flow through the metallic shell of the enclosure than going inside through the cable. In fact, for high enough frequencies, when most of the current flows near the external surface of a cable, due to skin effect, it cannot penetrate the shielded enclosure, and will continue its way concentrated on the external surface of the wall due to the same skin effect.

The same applies to shielding structures like Faraday cages, in spite of the mesh openings (as long as, obviously, within the frequency limit imposed by the mesh size). Figures 1a, 1b and 1c show an example in which a Faraday cage is immersed in an electromagnetic field produced by a distant source. Initially, fig. 1a, with no conductor traversing the cage wall, the field inside is much lower than outside. In fig. 1b a conductor traverses the cage wall, without making contact with it, resulting in the penetration of electromagnetic field inside the cage. In fig. 1c the same conductor is bonded to the wall and, consequently, the field penetration is significantly reduced.

Figures 1d and 1e show the currents on conductors for the same situations as in fig. 1b and 1c, but the excitation is now made by a current source inserted in the conductor that enters the cage. Note the higher current intensity at a point of discontinuity of the conductor, due to current wave reflection, which in one case occurs at the base, inside the cage (fig. 1d) and, in the other case, at the point the cable is bonded to the cage wall (fig. 1e).

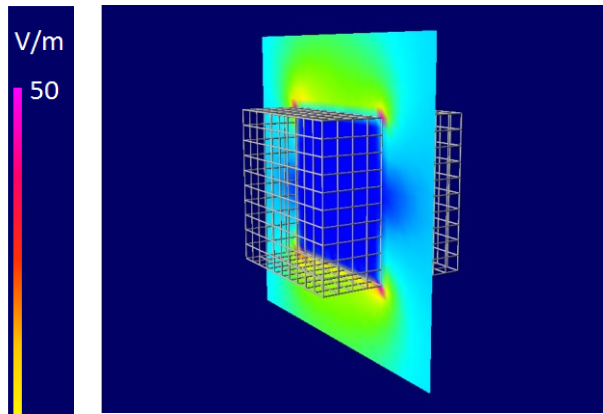

Figure 1a: Mesh-shielded box (Faraday cage) of dimensions $0.5 \times 0.5 \times 0.5$ m, illuminated by electromagnetic field from distant source; $f = 100$ MHz. No conductor enter the cage. The color plane cutting the cage in the middle indicates the total electric field amplitude, according to the scale on the left. Note that the field inside the cage is much lower than outside.

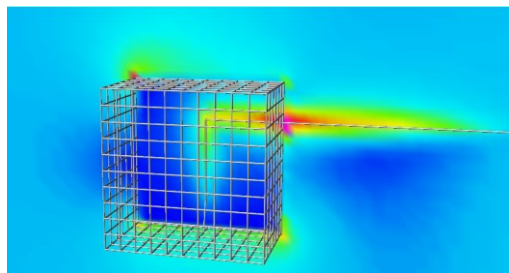

Figure 1b: A conductor pass through the cage wall without making contact with it. Note that there is electric field inside the cage, specially around the conductor.

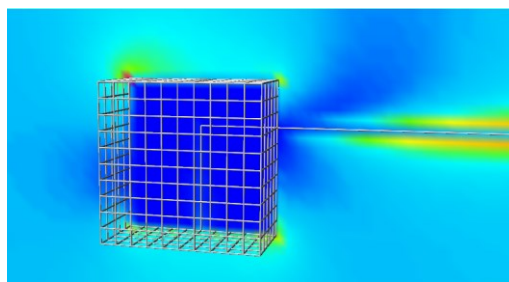

Figure 1c: The same conductor that traverse the cage is now connected to the wall. Again, the field inside is significantly reduced.

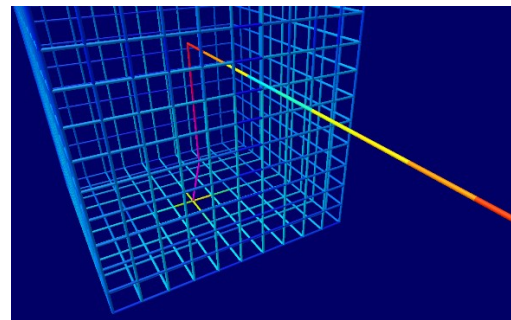

Figure 1d: Same situation as in fig. 1b, but for current source ($f = 100$ MHz) directly inserted in the conductor, 5 m away from the cage; Amplitudes according to the scale on the right-hand side.

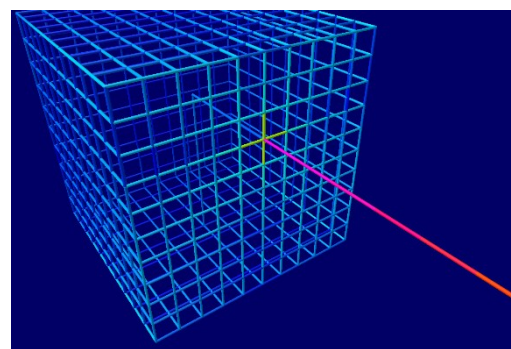

Figure 1e: Same situation as in fig. 1c, but for current source ($f = 100$ MHz) directly inserted in the conductor, 5 m away from the cage; Amplitudes according to the scale on the right-hand side.

In general, waveguides and cable shielding, including the external conductors of coaxial cables as well as metallic cableways (conduits, ducts, channels, trays and ladders) and earthing conductors can and should be directly bonded to the metallic parts of the shielded structures. Likewise, live power supply conductors and unshielded data/signal conductors should be bonded to the structure too, via filters and surge protective devices (SPD).

In this context, not only the spatial shields are included (i.e. those that completely involve a volume to be protected), but also certain open shielding topologies such as bonding mats, which are meshes of conductors installed near complex mission-critical systems such as telecommunication centers, datacenters and others. Besides diverting the unwanted currents, these bonding mats have the function of spreading (diluting) the current in a wide area, reducing its effects on the system [1].

A good deal of electromagnetic interference (EMI) problems and equipment damages are caused by conducted disturbances originated by nearby sources, which have strong interaction with the installation cables. In addition, the frequencies of such disturbances are not necessarily very high, putting the installation subjected to these disturbances in a region known as near-field region, where the fields have more complex structures and very strong induction capacity when the sources produces high currents (low-impedance sources), which is common.

Furthermore, these sources are characterized for not being concentrated (as an antenna, for example), but for being typically distributed on long paths, producing interactions with the installations circuits that can spread over a wide area and couple in different ways in each part of the installations.

These electromagnetic disturbances have known origins: lightning, switching and faults in electrical installations (transient disturbances), and the circulation of harmonics due to non-linear loads and high power switched converters (continuous influence disturbances). Note that, indeed, these sources have distributed effects along exposed and widely spread cables in the installations.

The interactions between these sources and circuits are naturally studied from the currents: direct current injections (galvanic/resistive coupling) and inductions (inductive coupling). Even though the reality is much more complex, some simplified circuit models can serve as powerful tools in the transmission of basic notions about how to deal with unwanted currents at the boundary of an installation or equipment.

Fig. 2a shows a shielded enclosure and an incoming shielded cable, and the cable shield is bonded to the metallic parts of internal equipment, being, for study purposes, represented by a direct bonding to the base of the metallic enclosure, inside. The enclosure is connected to the earthing system, represented by the dashed line, by the bonding c . The cable shield is also connected to the earthing system by means of an external conductor that is intended to divert an as large as possible part of current i to earth, since it is an unwanted current in the enclosure internal environment.

In fig. 2b, Z_1 and Z_2 denote the connections impedances from point a down to the earthing system, through which the current i returns to the source. The mutual couplings are omitted for the sake of simplicity of the model. The bonding c , in this case, is part of Z_2 . This is an important detail because, if the enclosure is far away from the earthing system, e.g. at the top of a building, $Z_1 \approx Z_2$ (assuming that inductances are dominant) and the current sharing is poor, tending to be close to 50/50 %.

Z_A and Z_B denote the earthing systems impedances associated with the current source and with the enclosure. It shall be minded that the current has to return to the source and, in this case, the earth

is part of the return path. Note that currents do not flow to earth without a reason. In fig. 2b, the current going into the earth through Z_B must go out through Z_A , to close the circuit.

It is easy to see that for $i_2 \rightarrow 0$, we have to make $Z_1 \rightarrow 0$ (once Z_2 cannot be increased). Note that the earthing impedance Z_B has no effect on the current division i_1/i_2 .

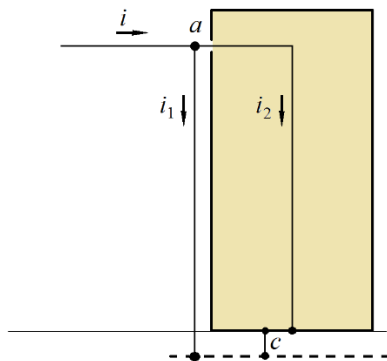
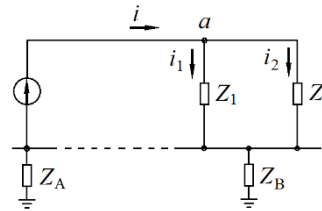

Figure 2a: The current i is divided between the external earthing connection (i_1) and the continuation of the coaxial cable inside the equipment (i_2).



$$i_2 = i \frac{Z_1}{Z_1 + Z_2}$$

Figure 2b: Representative circuit of the configuration shown in fig. 2a.

In the practice, for reducing Z_1 the external conductor has to be short and have large transversal dimensions. Considering that the length cannot be changed and that the inductive component of the impedances are dominant, then the external conductor has to have a cross-section perimeter much larger than that of the coaxial cable and of the bonding c , i.e. it has to be a very wide conductor, as a metal sheet. If the enclosure is located far away from the earthing system, the long length of bonding c will make the situation very difficult.

Let us consider, now, that the connection of the coaxial cable to earth is not made by means of a single conductor, but through the metallic enclosure itself, making use of the existing bonding c to reach earth. This idea has a very positive consequence: the bonding c is transferred from Z_2 to Z_B branch (see fig. 2b), allowing that the current division be controlled in a more localized way, i.e. at the own enclosure. A shielded enclosure is a naturally low impedance structure, electrically continuous, so that the current quickly disperses through its metallic parts and, therefore, reduces the mutual coupling between the current through it and the circuits in its interior.

If the enclosure is properly used to divert the current out from the cable and if it is possible to consider its impedance negligible, Z_1 is reduced to become the bonding impedance between the cable and the enclosure. Fig. 3 depicts such situation. The inductive component of Z_1 is function of the area A indicated in the figure, and it decreases with the reduction of A . Note that for a “360° bonding”, mentioned in the beginning of this section, $A \rightarrow 0$, thus, $Z_1 \rightarrow 0$ (both inductance and resistance). The desired result $i_2 \rightarrow 0$ is achieved.

An important observation that can be made about fig. 2 is that it is advantageous to position the cable entrance close to the point at which the diverted current finds its way out from the enclosure. It is the same as reducing the length of Z_1 . This detail will be discussed soon.

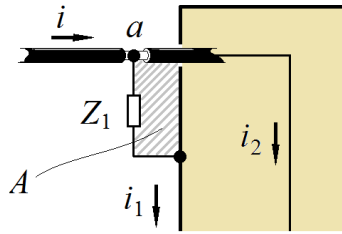

Figure 3: Bonding of a cable shield to the metallic structure of a shielded enclosure. The effectiveness of this bonding increases with the reduction of area A .

The problem with cable entrances seems to have been easily solved in the previous case. In fig. 4, on the other hand, there is a more difficult situation: two cable entrances are located in separate points of the enclosure, points a e b .

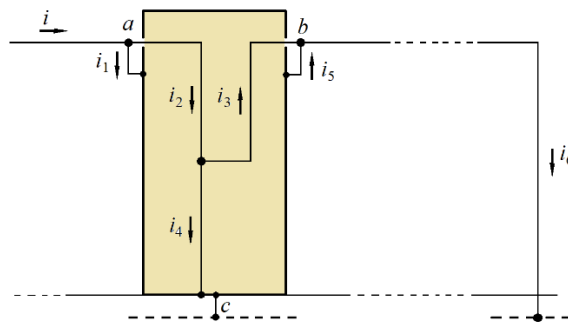

Figure 4a: Situation with two separate cable entrances. The current i , brought by the cable arriving at entrance a , which must return to the source through the earth, finds an alternative path to earth through the other cable at entrance b .

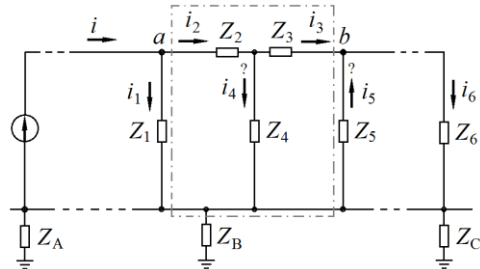

Figure 4b: Representative circuit of the configuration shown in fig. 4a. The question marks on arrows i_4 and i_5 indicates that the current directions depends on the values of the circuit impedances. The cable shields are bonded to the enclosure walls, via impedances Z_1 and Z_5 . Bonding c is part of Z_B .

Differently from previous case, in this case, even if $Z_1 = 0$ there will be current still passing inside the enclosure to reach earth via Z_C , unless $Z_B = 0$ or $Z_6 = \infty$ (in this case, any equipment represented by Z_6 could not be connected to earth, what is not allowed most of the times).

To eliminate the current inside the enclosure, one solution is to make $Z_1 = 0$ and $Z_5 = 0$, i.e. the cable shields have to be perfectly bonded to the enclosure at both cable entrances. Note that by doing $Z_1 = Z_5 = 0$, impedances Z_2 , Z_3 and Z_4 are short-circuited by the enclosure.

Generalizing, all cables through all cable entrances have to be perfectly bonded to the enclosure to avoid that current penetrates in the enclosure internal environment.

Note that this protection measure does not depend on the earthing system. The lower is Z_B comparatively to Z_C , more current will flow through the enclosure in direction to the local earth. The higher is Z_B , more current will flow through the enclosure from a to b , in direction to Z_C , without any harm to the internal equipment. This is valid, of course, if the enclosure impedance is negligibly

small to the passage of current in any direction. This leads us to an interesting comparison: a flying airplane being hit by lightning. The lightning current hits a point and exits by another point, flowing through the metal body of the aircraft, without penetrating in it, and there is no earthing connection!

To arrive at this solution, the impedances of current paths through the enclosure were considered negligible. For a well-shielded enclosure, with good electrical continuity among all parts, this approximation is not bad. In the cases of poor or absent shielding, a solution to reduce the unwanted currents inside the installation is making that all cable entrances be as close as possible to each other, ideally converging to a single point, as shown in fig. 5.

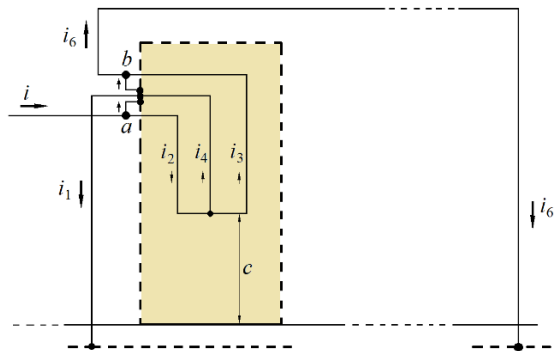

$$i_2, i_3, i_4 \approx 0$$

Figure 5a: Situation in which all cable entrances are located very close to each other, practically at a single point. The current i , brought by the cable arriving at entrance a does not find a way out by the internal circuits, flowing outwards through the external connections only. Here, c does not indicate an electrical bonding, but a separation.

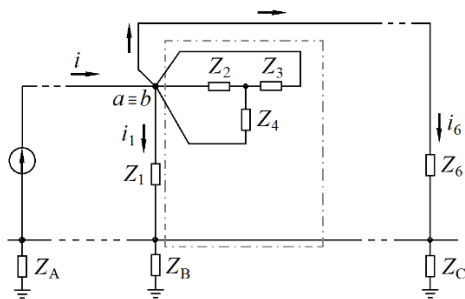

Figure 5b: Representative circuit of the configuration shown in fig. 5a. The bondings of cable shieldings at a and b are placed so close that they practically merge together. Z_1 and Z_5 (fig. 4b) merge into only one impedance to earth, Z_1 .

In fig. 5b, where $a \equiv b$, it can be seen that no current can flow to the internal circuits. On the other hand, fig. 5a shows that the connections to the common point have a certain length, so that any impedance between a and b justifies the injection of some current to the internal circuits, i_2 , i_3 and i_4 . The lower the impedance between a and b , the lower the current to the internal circuits. Because of that, it can be seen here, also, the importance of “360° bonding” to all cables.

It is clear that additional measures involving the internal circuits shall be taken, in this case, to reduce electromagnetic inductions to the internal circuits from i , i_1 and i_6 .

Note that for avoiding current injection into the internal circuits, it is not enough to optimize the bonding of the cables to an ideal single point of entry, but it is also necessary to keep the internal circuits isolated from earth (and other earthed metallic parts, except at the point of entry). The separation c in fig. 5a warns for the need of such a separation/isolation.

Note that it falls into an earthing configuration for the internal installations known as “single-point”. This configuration can be effective for small installations if the separations are well defined, installed and maintained, as high voltages can appear over these separations due to lightning inductions. Also, single-point concept normally loses its effectivity with the increase of frequency.

In reality, it is difficult to find installations with perfectly implemented single-point earthing topology, or that are even suitable for it. The solution generally falls into an earthing configuration in which the internal installations stay physically close to, and bonded at multiple points to a common bonding network (CBN), that is a large and dense enough system of interconnected conductors intended to take a good share of unwanted currents to itself, dispersing them to reduce their effects on to the installations.

Independently of the earthing configuration of the internal installations, the implementation of cable entrances at a single point is advantageous and recommended, in any case, for shielded or unshielded installations, as the currents brought by cables tend to be lower in the internal installations. Note in fig. 5 that even if separation c is not observed, the current circulating internally is very small if $Z_1 \ll Z_2, Z_3$ and Z_4 . This solution is often referred as “single point of entry”, where all cables enter and their shields are connected to a common conductive frame or solid structure that surrounds the bundle of cables. When this conductive structure is a large metal plate, it can be referred as “common intake plate”.

In summary, for protecting the internal installations against radiated electromagnetic fields and for preventing the penetration of intense conducted disturbances (lightning surges, for example), the cable shields, and any other conductive parts that cross the boundary of the installation, shall be properly bonded to earth or to the available earthing arrangement at the points of entry. In the case of shielded structures, the cable shields shall be bonded to the shield wall. In the case of installations with poor shielding or no shielding at all, the single point of entry solution is indispensable.

It is common, however, to observe that the earthing of cables at cable entrances are made in inadequate, poorly efficient ways, losing much of the shielding provided by the shielded structures, or allowing the ingress of more intense conducted disturbances in unshielded installations.

The situation is particularly critical concerning lightning protection, which is one of the major threats for equipment and installations, especially those served by cables highly exposed to lightning, e.g. antenna cables from high towers, aerial cables of long external networks, cables in large industrial, oil and mining installations, and cables in tall buildings with precarious surge protection measures (SPM) [2].

Diverting lightning currents and reducing their effects in electrical installations is very important, being deepened, in some respects, in the following section.

Lightning

□ The importance of diverting lightning currents and reducing their effects in the electrical installations

The biggest problem with direct lightning strikes to electrical installations or nearby lightning are the high intensities involved in the phenomenon, so that the concern is not only the possibility of EMI, but also the high risk of equipment damage.

It is a natural phenomenon representing one of the highest threats to electrical installations and it is frequent in tropical regions. In a country like Brazil, relatively tall structures such as mobile telephony antenna towers or buildings with heights around 60 m, for example, can be hit by lightning once a year or more, depending on the geographic location and topography. Higher structures are even more frequently hit. The spectral content of a lightning discharge current has significant amplitude, continuously distributed over a wide frequency range, from 0 Hz up to a few MHz. For these reasons, lightning is an important reference in the study of cable bonding at the entrances of electrical installations.

The international standard IEC 62305-1 [3] provides lightning current parameters that are relevant for lightning protection engineering. To have an idea, for the highest lightning protection level (LPL) in the standard, LPL I, the recommended values of amplitude and average rate of rise of the lightning current are 200 kA and 200 kA/ μ s, respectively. The amplitude defines the capacity of conductors to resist the direct impact of the lightning channel and/or to conduct the current (thermal effects and electrodynamic forces), while the current rate of rise defines inductive effects on the current paths and nearby circuits, including the possibility of occurrence of dangerous sparks.

The example of fig. 6 shows how the shielding effectiveness of a shielded structure is wasted when a conductor carrying part of lightning current is allowed to enter the structure without any attention to the need of bonding the conductor to the structure.

Consider a circuit formed by the interconnections (power supply, data/signal, protective earthing etc) between two equipment that define a plane area of 4 m² (2 × 2 m). Suppose that a lightning current flows in the same circuit plane, 10 m away from its center, as indicated in fig. 6a, and that the current has a maximum rate of rise (di/dt) of 140 kA/ μ s. In this case, the induced peak voltage along the circuit is 11 kV, approximately, which is above the rated impulse withstand voltage of any equipment in low-voltage electrical installations < 1000 V (see Table 44.B in [4]).

If the same circuit is placed in a metallic shielded enclosure², fig. 6b, the estimated induced peak voltage on the circuit, for the same lightning current 10 m away, is lower than 1 V, i.e. an attenuation higher than 10,000 times if compared with the previous case, without the enclosure.

² A 2-m radius, solid cylindrical aluminium enclosure was considered (to simplify the calculations), with a 2-mm thick wall and a current impulse with duration $t_{50/50\%} \cong 50 \mu$ s, which is shorter than the diffusion time through the wall that is 175 μ s. The calculated induced voltage on the 4-m² circuit inside such shielding was 0.2 V.

Suppose, now, that 5 % of the lightning current is allowed to go inside the shielded enclosure, passing near the circuit under consideration, as shown in fig. 6c. In this case, despite the current being significantly lower, the inductive effects are very intense in the vicinity of conductors, so that the induced peak voltage is high again (4.5 kV).

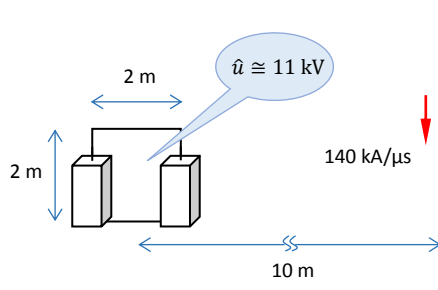

Figure 6a: Lightning current with $di/dt = 140 \text{ kA}/\mu\text{s}$ induces 11 kV in a 4-m² circuit 10 m away.

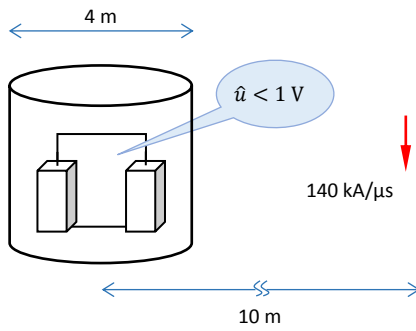

Figure 6b: The induced voltage is lower than 1 V when the circuit is protected by a shielded enclosure (Al, 2-mm thick).

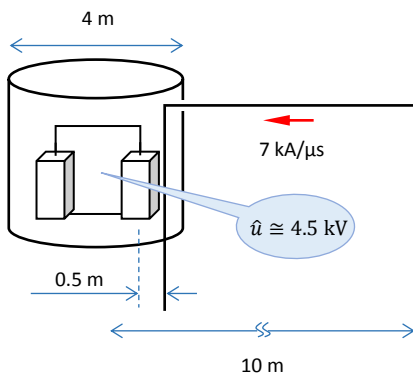

Figure 6c: The induced voltage is 4.5 kV when 5 % of the lightning current is allowed to penetrate the shielded enclosure and pass near the circuit.

Even if only 1 % of the lightning current were allowed to pass near the circuit, as shown in fig. 6c, the induced voltage would be near 1 kV. The shielding is lost.

Note that the considered circuit area in fig. 6 is consistent with interconnections between equipment in a small installation. The induced voltages are function of the current rate of change and of the geometric relations involving the current path and the circuit suffering the induction. The induced voltage increases with the increase of di/dt and circuit area, and with the decrease of the distance between them. Therefore, in an installation where equipment, including metallic infrastructure, form larger loops, the passage of lightning current surges near these loops will result in even higher induced voltages.

Figures 7a and 7b are photos of a typical telecommunication installation, a radio base station (RBS) for mobile telephony, where a large number of coaxial cables (antenna feeders) come from tower and enter the equipment room (a container-like shelter), fig. 7a, and various equipment cabinets, fig. 7b.

Figure 7a: Telecommunication installation where a large number of antenna cables can be seen entering the equipment room.

Note: Photograph taken by the author, from public space, of a RBS from various telecom companies sharing the same tower.



Figure 7b: Same site as in fig. 7a, where a number of antenna cables go to telecommunications equipment in outdoor cabinets installed at tower foot.

It is common to see the earth bonding of antenna cables at cable entrances made by means of earthing kits that bond the external conductors of coaxial cables to an external earthing bar, which is installed right below the cable entrance area, as shown in fig. 8. The bar is connected to the earthing system by one or two conductors, typically. This earthing solution is not the most efficient, as the test results presented in the next section demonstrate, but it is usually adopted, especially in telecommunication installations [5].

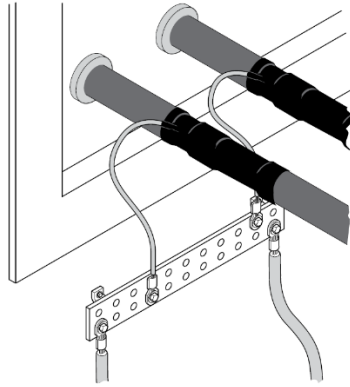

Figure 8: Traditional earthing solution for coaxial cables with earthing kits; Figure copied from [6].

In the cases of installations of the type shown in fig. 7a, it is likely that a share of the lightning current traverse the internal installations, passing through equipment and internal cables, despite all cable earthing made externally at tower and room/cabinet entrances.

The situation is common in several types of installations and involves not only directly injected currents from lightning, but also induced currents from nearby lightning. Fig. 9 schematizes some situations in which it is possible to see how lightning currents flow through interconnected equipment and installations. Figures 9a and 9b shown cases of direct current injection and fig. 9c shows a case of induction. No inductive coupling was indicated in figures 9a and 9b, but they occur, simultaneously, in all cases, if the installation is not shielded.

While the penetration of current in internal installations was analyzed by the simplified models of figures 2 to 5, aiming at showing the importance of bonding the cables at cable entrances, the current distribution in real installations is rather complex, given the large number of paths the current can take and their interactions. Such paths involve data/signal interconnections, power supply, earthing arrangement, equipment conductive parts and other conductive parts of the infrastructure.

Several coupling modes can result in overvoltages at power supply and data/signal ports of equipment. The higher the current allowed to enter an installation, more attention shall be given to the internal protection measures. It means more dependence to shielded cables and metallic cableways, these working as cable shielding, to routing and disposition of cables and to SPD, inside the installation.

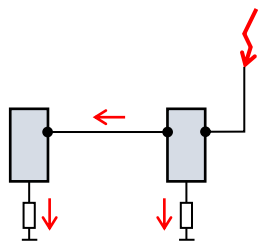

Figure 9a: Part of lightning current reaches an equipment and flows to the earthing system and to other interconnected equipment.

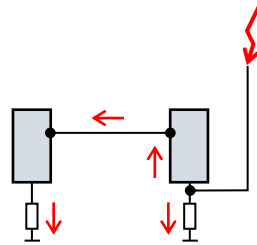

Figure 9b: Lightning hits the external LPS of an installation and goes to the earthing system; Part of it flows through the equipment of the installation to an interconnected installation.

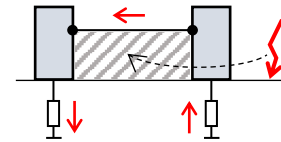

Figure 9c: Electromagnetic induction from nearby lightning makes current to circulate on loops formed by interconnections between equipment of the same installation or of different installations.

Note: in fig. 9, the impedances can represent the earthing system impedances of different installations or the impedances of the connections from different equipment to the earthing system of an installation.

On the other hand, the more effective the diversion and dispersion of current outside the installation, less critical is the internal configuration of the installation. In other words, the lower the care at cable entrances, the higher the attention to the internal installations, and vice-versa.

Fig. 6 showed that induced voltages in internal circuits of an installation can be very high when impulsive extraneous currents flow near these circuits. Fig. 10 depicts some typical configurations and important details of the installations, particularly of those potentially exposed to lightning current injection, as shown in fig. 7.

In fig. 10, a lightning current surge (i) is conducted by a coaxial cable (16) towards the radio equipment (4). Note: in the figure, only currents derived from (i) are considered. A connection from the outer conductor of the coaxial cable to the earthing system is made at cable entrance, (8)+(9), through which a current (i_1) is diverted from the cable.

The remaining current (i_2) continues its way on the coaxial cable to the radio equipment. Within certain limits, this type of equipment is designed to withstand current surges coming through the cables. The cable connection is made by a coaxial connector that bonds the outer conductor of the coaxial cable directly to the equipment metallic enclosure (360° connection), so that the current surges flow through the enclosure, normally not causing damages³ to the equipment.

The current, however, go through all paths until it finds the earthing system (2) and other external lines as, for example, the AC power line (15), since it also makes connections with earth at various points along the line.

Note that part of the current can flow on power supply cables (11) and on data/signal cables (13), if they have a common conductor bonded to equipment enclosures at both ends, e.g. cable shielding or the outer conductor of coaxial cables. A current surge on these cables can cause overvoltage on the respective ports of equipment. Because of that, it is important to combine protection measures that 1) remove the surge currents from these cables and 2) limit the overvoltages by means of SPD at equipment ports.

³ The cable earthing concepts treated in this article are usually applied at equipment level by radio equipment manufacturers, especially those connected to antennae on high towers.

If the data/signal interconnection (13) is balanced, e.g. an unshielded twisted pair cables, the surge voltage induced along the trajectory of such a cable, due to the passage of current surges throughout the installation, will appear in common-mode at the interconnected ports. If the induced voltage exceeds the resistibility level of those ports, there will be damages and, therefore, specific protection measures are necessary for that interconnection.

Note that if the current diversion at cable entrance is effective ($i_2 \ll i$), all currents indicated in the diagram of fig. 10 will be reduced. Consequently, the risk of damages is also reduced.

Next section will focus on this part of the installation, the cable entrance, where a criterion for the efficiency of cable bonding will be defined and measured for some of the most common earthing configurations, including the excellent earth bonding provided by ROXTEC BG™.

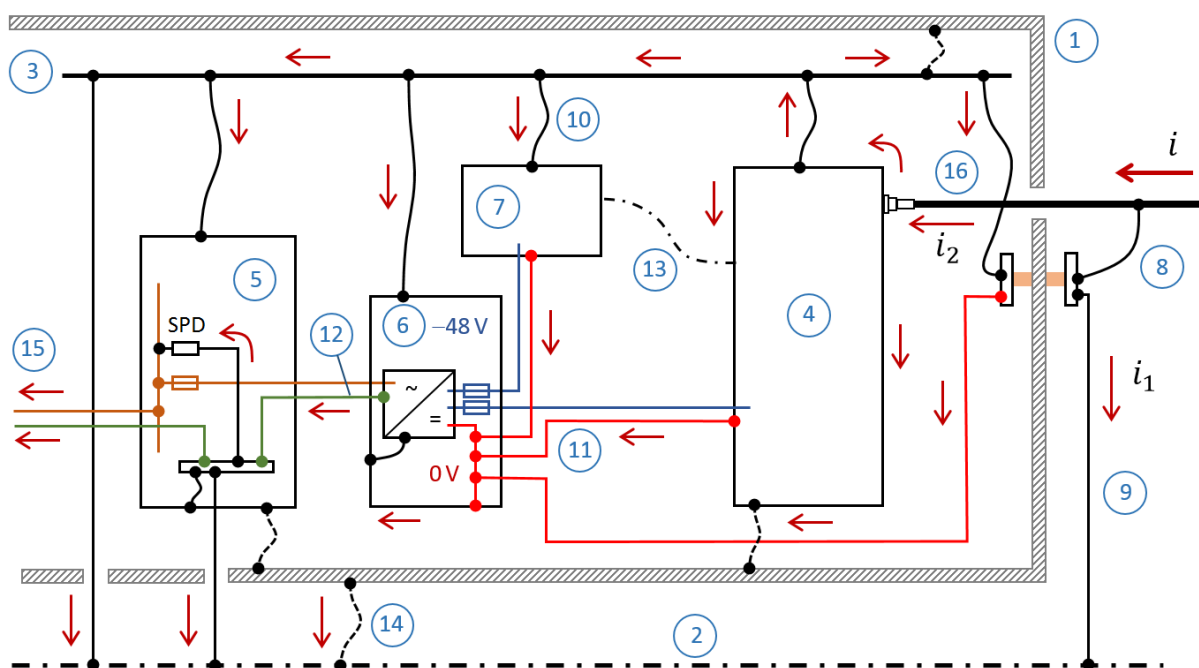

1. Contour of an equipment room, metallic (container, cabinet, shielded room etc) or isolating (brick, wood)
2. Earthing system/electrodes, the system of buried conductors in contact with soil
3. Internal earth-ring conductor, generally overhead (*halo system*) or under raised floor
4. Radio equipment, to which the antenna cables are connected; DC powered
5. AC power distribution frame/board/panel
6. Rectifier system, AC/DC, - 48 V
7. Any equipment, interconnected with the radio equipment and DC powered
8. Earthing bonding (pigtail) between coaxial cable and the external earthing bar, isolated from the structure in this example
9. Connection between the external earthing bar and earthing system
10. Earthing connections involving ring (3)
11. DC-supply return conductors (0 V), bonded to power supply (6) and load equipment (4),(7)
12. Protective conductors (PE), green color lines
13. Data/signal interconnection between equipment (4) and (7), which can be coaxial, balanced pairs, shielded or not, or other
14. Fortuitous or intentional bonding (dashed lines), between internal installations and metallic structure, in the case of shielded room or metallic enclosure, or between metallic structure and earth
15. AC power line; part of the current goes to the external network through PE or PEN, and live conductors, via SPD
16. Coaxial cable bonded to the metallic parts of the radio equipment (4), through which a part (i_2) of the lightning current (i) penetrates in the internal environment of the installation

Figure 10: Scheme where an external coaxial cable enters the installation and carry extraneous current surges to the internal installations, which finds several paths to flow to earth, including other external cables entering the installation (AC line).

Cable bonding efficiency tests

A test was elaborated to verify the efficiency of some cable bonding configurations at the passage through the wall of a shielded cabinet. The tests were made by applying current impulses on the outer conductor of a coaxial cable that enters the cabinet, recording these currents and the currents diverted to earth, outside or through the cabinet structure, by the cable earthing arrangement.

The earth bonding efficiency was defined as the ratio between the current diverted by the cable earthing arrangement and the applied current (fig. 11):

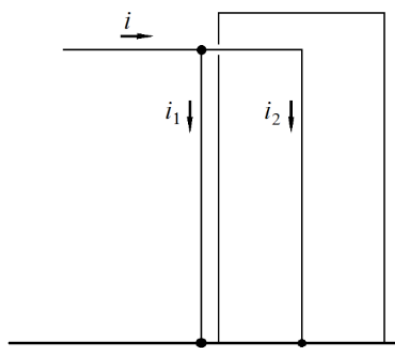

$$\eta = \frac{i_1}{i} = 1 - \frac{i_2}{i}$$

(Current peak values)

Figure 11: The applied current i , the diverted current i_1 and the current entering the cabinet i_2 are used to define the efficiency η .

It is clear that the best results are when $i_1 \rightarrow i$ ($i_2 \rightarrow 0$) and $\eta \rightarrow 1$ (100 %).

A shielded cabinet was specially designed and produced for the tests. The cabinet was laid on a metallic ground plane and connected to it, at several points, through which the applied current returned to the generator, see fig. 12 and 13. Cabinet and ground plane material is aluminium.

The current was injected on a ½" coaxial cable with overall diameter of 16 mm, approximately. Two Pearson current sensors and an oscilloscope recorded the waveforms of the applied current and of the current entering the cabinet. The current sensors were placed near the generator output and near the base of the cabinet, respectively, as shown in fig. 13.

The three main earth bonding tested configurations denominated cases 1, 2 and 3, are described in fig. 14 and table 2. The ROXTEC components used in the tests are given in table 1.



Figure 12
Photo of the test site.

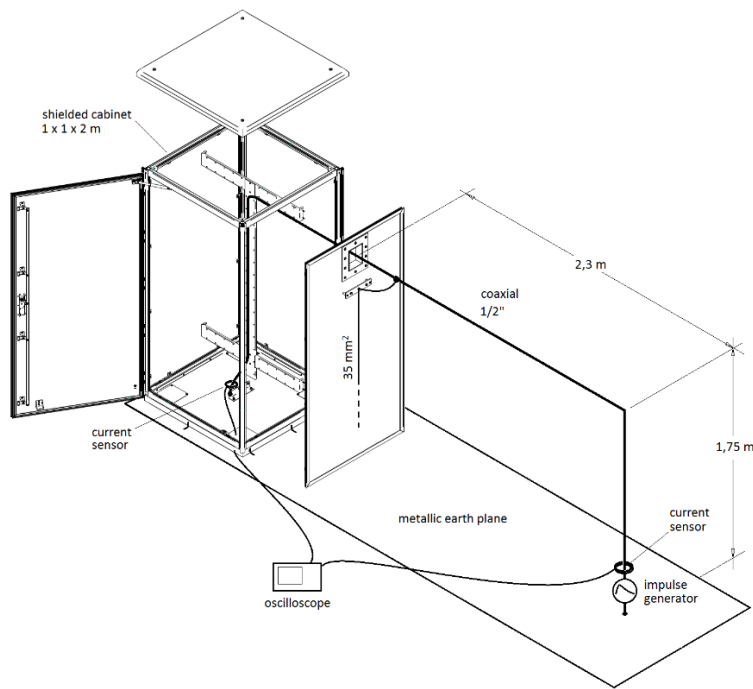
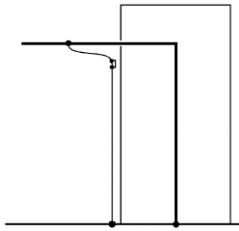

Figure 13: Basic test configuration. Exploded view of the shielded cabinet; the impulse generator injects current on to the coaxial cable, which is bonded to the cabinet base, internally; the current returns to the generator by the metallic plane. The coaxial cable is earthed at cable entrance, being connected to the earth plane via an external conductor or via the cabinet itself, in this case the bonding to the cabinet is made via a pigtail connection or via a ROXTEC BG B.

Table 1: ROXTEC components used in the tests.

Cases	1, 2	3
Modules	RM 40 10-32 (1x) RM 40/0 (8x)	RM 40 10-32 BG B (9x)
Wedge	120 AISI 316	
Frame	GHM 4X1 AISI 316	

In cases 1 and 2, the ROXTEC modules are of insulating material, without bonding braids. These insulating modules were necessary to represent an installation where the coaxial cable were bonded via earthing kit only.



a) Case 1



Connection to earth via earthing kit, external bar and external 35 mm² conductor. See also fig. 12.



Cable entrance via isolating ROXTEC modules. Viewed from inside.

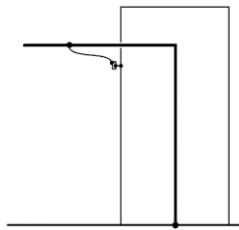

b) Case 2



Connection to earth via earthing kit to the external bar, which is bonded to the cabinet wall.



Bonding between bar and cabinet wall via two large flat braids, on both extremities of the bar.

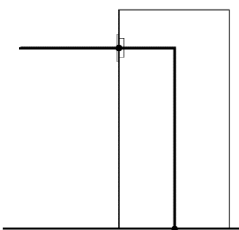

c) Case 3



Cable bonding to cabinet via ROXTEC BG B. The earthing kit appears hanging loose in the picture.

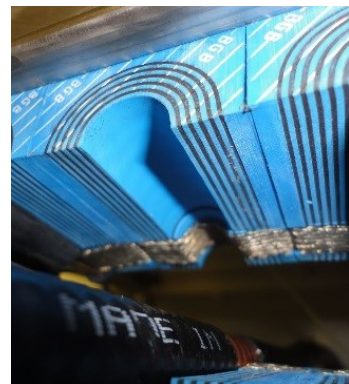

View of an open ROXTEC BG B module and the coaxial cable in position.

Figure 14: Details of the basic tested configurations; a) case 1, b) case 2 and c) case 3.

The applied currents came from two types of impulse generators specified in EMC standards:

- Surge, as per IEC 61000-4-5 [7]
- EFT/B, as per IEC 61000-4-4 [8]

The impulses were conveniently chosen for they are well known in the EMC area, being widely used by the electro-electronic industry for product immunity tests.

The generators supply voltage and/or current with specified waveforms under specified load conditions. During the immunity tests, when a generator like this is coupled to signal/data cables or connected to the ports of the equipment under test (EUT), normally via a coupling/decoupling network (CDN), the output voltages and currents end up modified due to the interaction between generator and circuits. The test procedures do not normally require the verification of the voltage and the current actually applied, but only the behavior of the EUT during the application of the disturbances.

In the tests presented here, the supplied current from generators were recorded as an important parameter in the tests, with the waveforms that naturally resulted from the interactions with the test setup. Fig. 13 gives some important dimensions of the circuit to which the currents were applied.

The applied current amplitudes in the tests are not relevant, since it is not the objective of the tests to verify the current carrying capacity of the earthing components⁴, and the results must be linear in a wide range of current values.

• Surge

The surge immunity tests have the purpose of verifying the immunity of electro-electronic products against lightning related surges.

The surge generator delivers two standardized waves on two distinct conditions: a voltage wave with shape⁵ 1.2/50 μs for the output terminals open, and a current wave with shape 8/20 μs for the output terminals in short-circuit, fig. 15. This generator is known as “combination wave generator”.

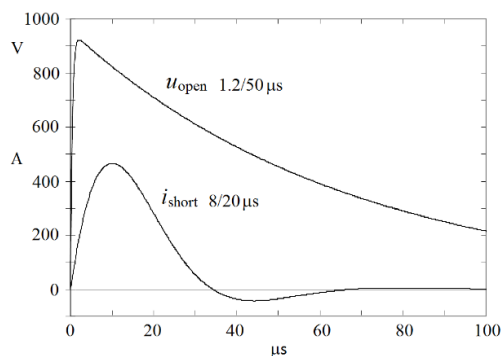

Figure 15: (Open) voltage and (short-circuit) current output characteristics of the surge generator, according to IEC 61000-4-5 [7]

⁴ The impulse current carrying capacity of ROXTEC BG™ are very high, as it can be seen in [6].

⁵ Wave-shape is commonly given in the form t_r/t_f , where t_r is the risetime and t_f is the fall time. For detailed definitions on the rise and fall times, see [7]. It worth mentioning that the fall time goes from a given time in the beginning of the impulse up to the point when the quantity falls to 50 % of its peak value, in the tail.

The voltage and current characteristics are not specified for other loads that are not open or short-circuit, and the wave shapes can vary⁶. The output impedance of the generator is defined as the ratio between the peak voltage and the peak current, for both the generator output open and under short-circuit, respectively. In the tests presented herein, the impedance was 2Ω .

- EFT/B

EFT/B stands for “*electrical fast transient/burst*”. This type of conducted disturbance is defined for electro-electronic product immunity tests against disturbances originated in power supply lines, where high-frequency oscillations occur due to load switching, contact bounces and so on.

Some basic characteristics of the impulses from an EFT/B generator are given in Fig. 16. Note that the impulses have very short risetime and duration: 5/50 ns. The specified impulse shape can only be obtained for the generator perfectly matched to a 50Ω load, in an adequate arrangement for high frequency tests, up to a few hundred MHz at least.

In the presented tests the shielding efficiency for EFT/B was verified focusing on the 5/50 ns impulse, which carries the highest frequency content of this type of disturbance. The applied current featured many oscillations due to wave reflections in the test setup, as the round-trip propagation times between generator and cabinet were much longer than the impulse risetime.

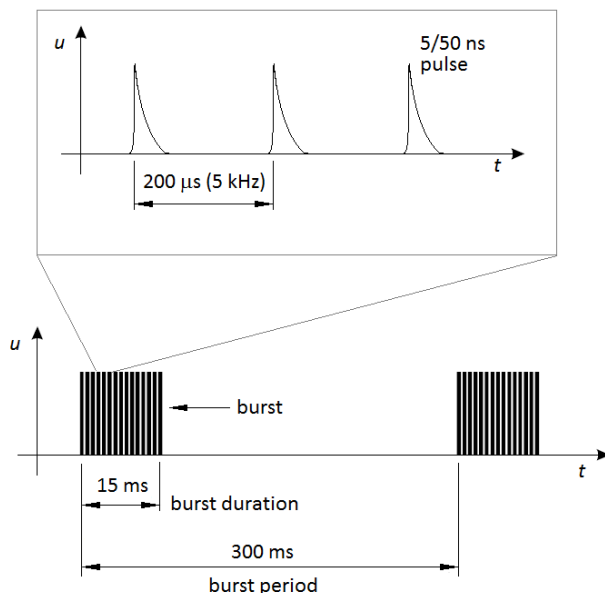

Figure 16: Representation of output voltage impulses on 50Ω load from an EFT/B generator; adapted from fig. 2 in IEC 61000-4-4 [8].

⁶ Studies made by the author of this article suggest that the surge generator closely behaves as if it were open for loads above 100Ω and in short-circuit for loads below 0.1Ω .

- Test results

Three main cases have been considered: 1, 2 and 3, corresponding to usual cable bonding configurations at cable entrances of installations and equipment. These configurations are schematized and described on table 2, together with efficiency measurement results. Some photographs are also shown in fig. 14 for the three cases. The measured currents are shown in fig. 17 for surge impulses and fig. 18 for EFT/B impulses.

Table 2: Cable earthing configurations and measured efficiencies.

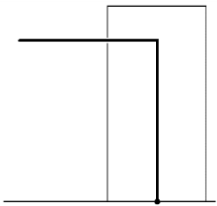
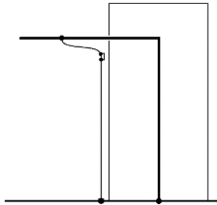
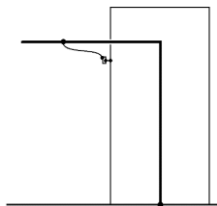
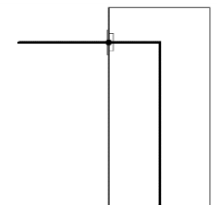
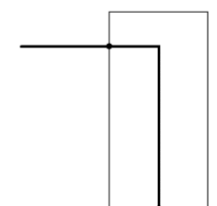
Case	Configuration	η (Surge)	η (EFT/B)	Case description
0		0	*	No care with cable entrance whatsoever
1		62,5 %	62 %	Earthing kit (0.6 m, AWG-6 cable and connections) connecting the coaxial cable to a bar isolated from cabinet wall, plus 1.5 m long, 35 mm ² cable from bar to earthing plane (fig. 12 and fig. 14a)
2		82,0 %	83 %	Earthing kit (0.6 m, AWG-6 cable and connections) connecting the coaxial cable to a bar bonded to the cabinet wall (fig. 14b)
3		99,4 %	99,5 %	Bonding to cabinet wall via REXTEC BG B (fig. 14c)
4		99,7 %	*	Cable directly bonded to a metal plate integrated to the cabinet structure (best possible bonding condition for this cabinet)

* Not measured.

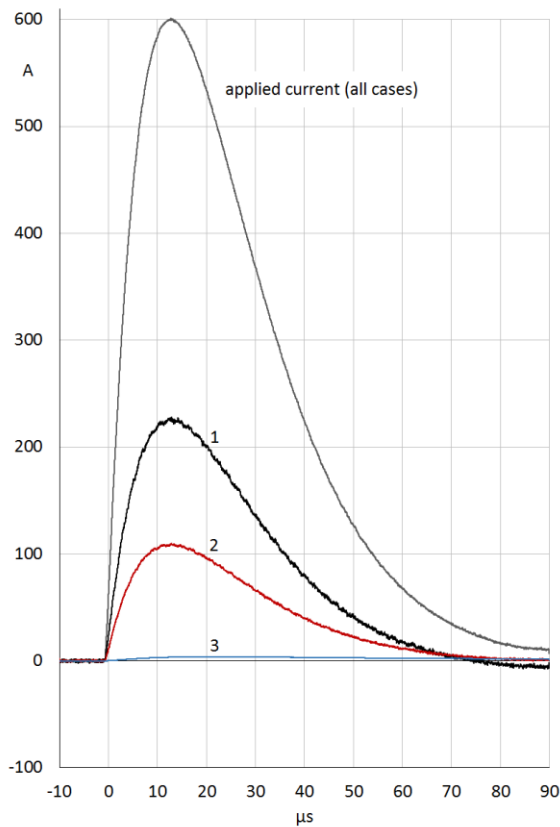

Figure 17: Surge test; Applied current and currents penetrating the cabinet in cases 1, 2 and 3. The surge currents applied in the three cases were very close to 600 A peak, so the results were normalized to that value, for presentation in the graphic.

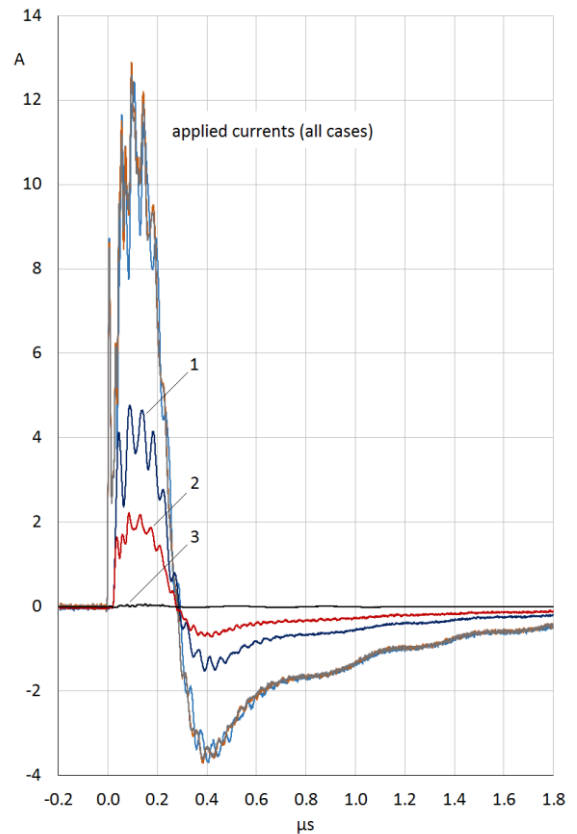

Figure 18: EFT/B test; Applied currents and currents penetrating the cabinet in cases 1, 2 and 3. The applied currents in cases 1, 2 and 3 correspond to curves in light blue, orange and grey, respectively. The applied current risetime is around 6 ns (first wave front).

Comments on test results

The main objective of the test was achieved. It shows the importance of earth bonding the cables at the cable entrance of a shielded structure, and other metallic elements that eventually penetrate the structure, and that the effectiveness of this bonding strongly depends on how the bonding is made.

The test results and bonding configurations are given in table 2, in terms of efficiency (η), and the current waveforms are shown in figures 17 and 18, which transmit the result in a very expressive way. The amplitudes of the currents that penetrate the shielded cabinet in case 3, for both surge and EFT/B, almost disappear in comparison with the current in the other cases.

With the coaxial cable bonded to the cabinet wall by means of ROXTEC BG B modules (case 3), the current entering the cabinet was just 0.5 or 0.6 % of the applied current. In the other bonding configurations, cases 2 and 1, the percentage were 17 % and 38 %, respectively.

The results for surge and EFT/B were very close to each other (see table 2), despite the high frequencies involved in the EFT/B impulses.

The differences as function of the bonding configurations are significant. Based on the results of table 2 and considering a lightning current surge with 7 kA/μs rate of rise, coming to a shielded room as in the example of fig. 6, the currents rate of rise and induced voltages inside the room would fall, proportionally, to the values given in table 3, depending on the bonding configuration. The case 0, as it can be seen in table 2, corresponds to a cable entering the room without any bonding to the wall.

Table 3: Current rate of change (di/dt) and induced peak voltage in a shielded room according to the example of fig. 6, considering the test results for surge, cases 1, 2 and 3. The $1 - \eta$ factor express the amount of current that enters the room, in %.

Case	$1 - \eta$	di/dt	\hat{u}
	%	(kA/μs)	(kV)
0	100	7	4.5
1	37.5	2.7	1.7
2	18.0	1.3	0.8
3	0.6	0.04	0.03

Besides the large reduction of current amplitude obtained in case 3, an inspection in the current waveform of case 3 reveals that it is slower than the currents of cases 1 and 2, since it has longer rise and decaying times, see fig. 19. This effect is typical in diffusion processes in metals.

It indicates that the bonding impedance of ROXTEC BG™ modules is very low, so that the current that enters a shielded enclosure after passing through ROXTEC BG™ modules, is not only controlled by its bonding impedance, but also, partially, by the diffusion of the current through the metal sheet to which the ROXTEC frame is attached to. This effect is more important at the immediate vicinity of the ROXTEC frame, where the current is still concentrated, dispersing out from the frame.

In other words, the impedance of the cabinet metal sheet near the ROXTEC is not negligible as compared with the bonding impedance of the ROXTEC modules to its frame. If the cabinet used in the tests had thicker wall, it would probably result in an even lower current amplitude for case 3, with longer wave shape.

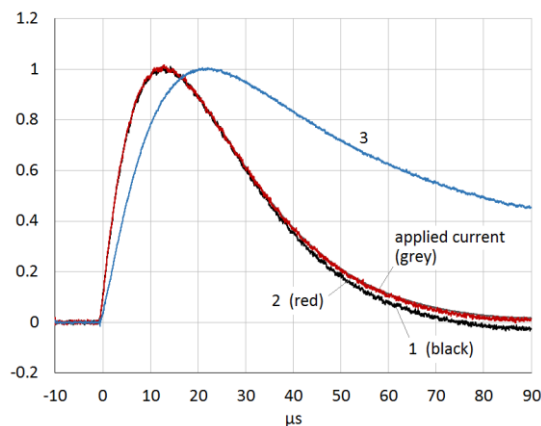
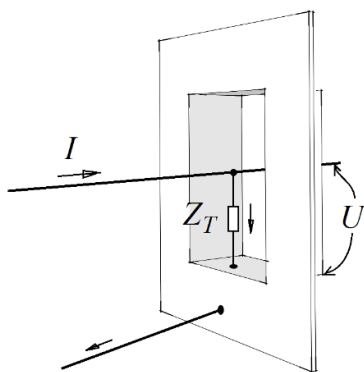

Figure 19: Currents of fig. 17 with their amplitudes normalized to unity. The maximum rate of rise of the current in case 3, through ROXTEC BG™, is approximately half the rate of rise of the other currents.

This somewhat subtle detail confirms that, despite the apertures in ROXTEC BG™ modules in the parts not occupied by cables and bonding braids, the electromagnetic leaking areas are too small and this, together with the multiple short and wide bonding paths, results in an extremely low bonding impedance between cables and frame.

This bonding impedance can be given as a transfer impedance (Z_T) parameter, that relates the voltage across the bonding path (U) by the current through it (I), this current being referred to an external circuit, as shown in fig. 20. In the picture, Z_T represents the bonding impedance from conductor to frame, through the connecting braids of BG modules. This impedance is normally given as function of frequency, as shown in fig. 21. The measurement is normally made with the frame attached to a shielded enclosure or a large plate, to shield the voltage measurement against induction from the circuit current.



$$Z_T(j\omega) = \frac{U(j\omega)}{I(j\omega)}$$

Figure 20: Transfer impedance (Z_T); A current I is applied on a conductor that makes contact with the frame via the bonding modules, flowing from the frame back to its source, on the same side. A voltage measured between the conductor and the frame is measured on the other side, U . The ratio U/I gives Z_T .

Fig. 21 shows the transfer impedance (Z_T) of a ROXTEC S 6x1 BG B set. The graphic is adapted from [6]. The resistive component of this impedance is in the order $0.01 \text{ m}\Omega^7$ while the inductance is the order of 0.07 nH (extremely low).

The solution virtually works as a 360° bonding up to rather high frequencies.

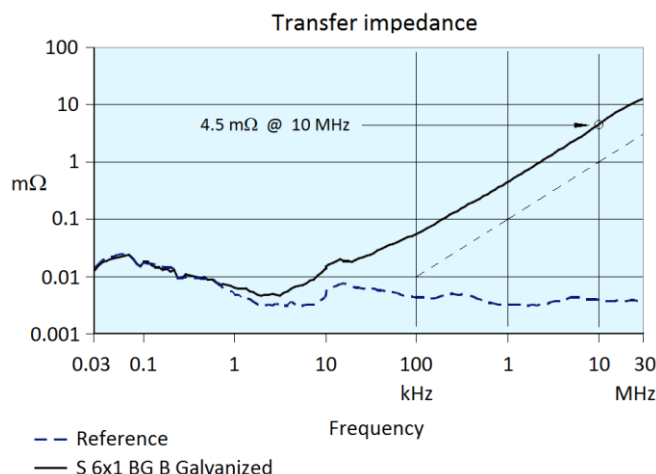

$$L_{T(10 \text{ MHz})} \approx \frac{|Z_T|}{\omega} = \frac{0.0045}{2\pi \times 10^7} \cong 0.07 \text{ nH}$$

Figure 21: Transfer impedance (Z_T) of a ROXTEC S 6x1 BG B, galvanized frame, in the frequency range $30 \text{ Hz} - 30 \text{ MHz}$. The straight dashed line shows the expected slope of any inductive reactance as function of frequency, and the transfer impedance curve has about the same slope from approx. 100 kHz up to the maximum frequency value.

⁷ Probably lower, as the values coincide with the reference line, which gives the lowest measurable value by the test setup.

Other considerations

□ Surges internal to the cables

The shielding effectiveness of cables are normally given in terms of transfer impedance (Z_T) that, in this case, is a distributed parameter with unit Ω/m . When a current related to an external circuit (I_e) flows on a cable shielding (or on the outer conductor of a coaxial cable or on a tube/conduit with cable shielding function), a voltage appears at the shielding internal surface (U_i), by diffusion of the electric field and by penetration of the magnetic field associated with the current, due to shielding imperfections⁸. This voltage is transferred and becomes related to the cable internal circuit, fig. 22.

For an electrically short segment (Δx) of a shielded cable ($\Delta x \ll \lambda$, where λ is the wavelength), with no current in its internal circuit ($I_i = 0$), the transfer impedance can be approximated by:

$$Z_T \cong \frac{U_i}{I_e} \cdot \frac{1}{\Delta x} \Big|_{I_i=0} \quad (\Omega/m)$$

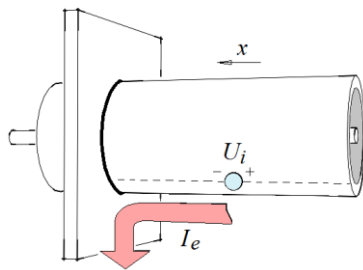

Figure 22a: Current related to external circuit flows on the cable shielding (I_e), which is perfectly bonded to a metal plate through a 360° bonding. A voltage (U_i) is transferred to the cable internal circuit and will propagate internally, no matter if the external current is diverted from the cable at some point.

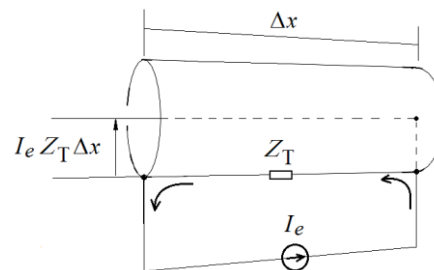

Figure 22b: Representation of voltage (U_i) transferred to internal circuit of an electrically short cable, appearing on a cable end if the circuit is closed at the other end.

The transferred voltage (U_i) propagates inside the cable and will, after propagation effects and drops on internal cable impedance, appear on connected circuit ports, even if these circuit are perfectly shielded. A ROXTEC BG™ or a perfect 360° bonding, such as a welded connection, cannot eliminate U_i , since this voltage is developed inside the cable and along its external run (where current I_e is high). Depending on the intensity of the external current, the transfer impedance value and the cable length, the internal voltage can be high enough to cause damages to the connected equipment.

The function of a good connection of cables at an installation cable entrance is to divert the external currents away from the internal installations. As previously discussed, in aggressive electromagnetic environments, like those exposed to direct lightning, these currents can be very high, being necessary to divert them before they enter. The protection against the effects of U_i depends on

⁸ When the shielding is of solid homogeneous material, as the wall of a metallic tube, the current is homogeneously distributed along the perimeter of the cross section and the transferred voltage is only given by diffusion of the electric field through the shield wall. The voltage is in general very small in these cases, especially if the skin effect is pronounced.

specific protection measures applied to the equipment ports to which the cables are connected, by the use of SPD, for example, or on a better cable shielding with lower Z_T , and/or on the removal of current from cable along its external run by means of additional shielding, cable routing and so on.

□ Earthing at cable entrances in non-metallic structures

The advantage of the efficient bonding between the cable shield and the conductive frame of a ROXTEC BG™ panel is lost if the connection between the frame and a point considered relevant for the purpose of earthing or equipotential bonding, is made by a relatively long conductor. It may happen when the frame is attached to a non-metallic wall like brick, wood or concrete, in an ordinary unshielded building.

Figures 2 to 5 and the discussions around them in section *Shielding and cable entrances*, are useful for a brief analysis about the installation of a ROXTEC BG™ in non-metallic walls.

Fig. 23 shows two earthing connections in a non-conductive enclosure, one is similar to the test configuration 1 (case 1, table 2), and the other uses a ROXTEC BG™. The two connections are made by conductors of the same type and length, resulting in earthing connection of practically equal effectiveness.

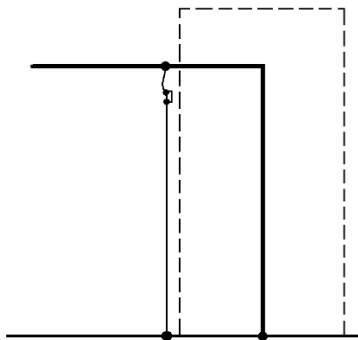

Figure 23a: Earthing of coaxial cable according to case 1 (table 2), non-metallic enclosure.

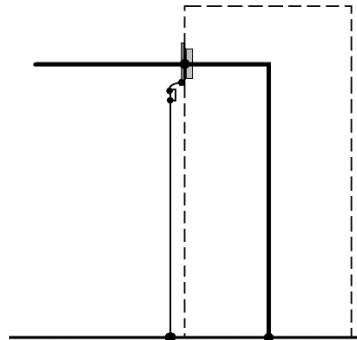

Figure 23b: Earthing of coaxial cable using a ROXTEC BG™, but via the same earthing conductor of fig. 23a; non-metallic enclosure.

Fig. 24 shows a solution for cable bonding at cable entrances with ROXTEC BG™ modules, where the ROXTEC frame is bonded to a 0.5 to 1 m wide metal plate that also makes the connection with the earthing system of the installation. Two 35 – 50 mm² (typical) earthing conductors separated by a distance equivalent to the plate width (0.5 to 1 m), provide a connection with an inductance that is practically equal to that of the plate⁹. The reduction of inductance is significant when two conductors are used instead of one, but it is not expressive if a third or more conductors are added in between, i.e. keeping the same total 0.5 to 1 m width.

⁹ A metal plate provides protection to cables that run very close to its surface, but for cables not close to it, its surge or high-frequency mutual impedance is not significantly lower than that of two paralleled conductors, as suggested in fig. 24.

An important advantage of the scheme shown in fig. 24 is that it complies with the idea of a single point of entry for cables (see fig. 5), ensuring a very low impedance between the cable shields of all cables entering through this point, due to the low impedance between ROXTEC BG™ modules.

It is particularly important and advantageous that the AC power lines enter through the metal plate shown in fig. 24 and that the plate be used for earth bonding the AC-line SPD. The main earthing terminal (MET) of the electrical installation, see IEC 60364-4-41 [9] and IEC 60364-5-54 [10], shall be shortly bonded to this plate, being the MET normally accessible from inside the installation. The plate, itself, can be the MET of the electrical installation, provided it complies with the requirements for this function, regarding material, size etc.

Note that the plate in fig. 24, or the two earthing conductors in parallel, are represented by Z_1 in fig. 2. A way to reduce this impedance, effectively, is by shortening this connection, i.e. by approaching the cable entrance to the earthing system. It shall be observed that, as the earthing system is a path for the currents coming in our out through the cables, such a physical approximation is, in reality, an optimization of the single point of entry concept.

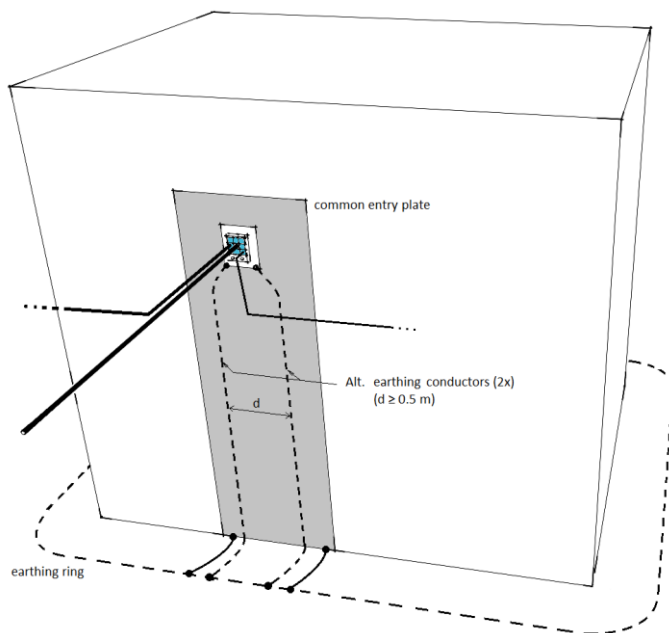

Figure 24: An unshielded building with walls made of non-conductive material. All cables enter in a common entry point, implemented with a ROXTEC BG™ panel that is connected to earth via a wide metal plate or by two paralleled conductors with a certain space between them.

If the cable entrance must contain several ROXTEC frames, these should be bonded to a single metal plate capable of housing all frames. The plate then makes contact with earth in the same manner as proposed in fig. 24. If two earthing conductors are used, these shall be connected to the metal plate. The metal plate then can be referred as the *common entry plate* or *common intake plate*, common in the sense of being common to all cables entering the installation.

Now, consider an unshielded installation far from the earthing system such as, for example, an equipment room near the top of a building, with antenna cables as shown in fig. 25, just to invoke a high risk condition. In this case, fig. 2 should be recalled to show that, for dealing with the current division between Z_1 and Z_2 , it has to be done locally, around the installation to be protected, with the help of shielding. The earthing system impedance, including a long connection to it (Z_B in fig. 2), has little effect on the amount of unwanted current traversing the installation.

If there is no spatial shielding involving the equipment room, for the current to flow around, at least a dense and properly installed bonding mat [1] shall be considered near the equipment. It has a shielding effect, as long as the equipment enclosures are bonded to it and the interconnecting cables, including power supply cables, are routed very close to it.

Fig. 25 shows a possible solution for handling the antenna cables entering the unshielded equipment room near the top of a building. The antenna cables are exposed to lightning current injection (i). A ROXTEC BG™ cable transit makes the bonding between the antenna cables and a bonding mat under the equipment cabinet, used to give passage to the part of lightning current that will inevitably pass through the installation (i_2). An external earthing conductor¹⁰, or two in parallel as in fig 24, despite being long, can take a good deal of the current coming via the antenna cables and conduct it directly to earth (i_1).

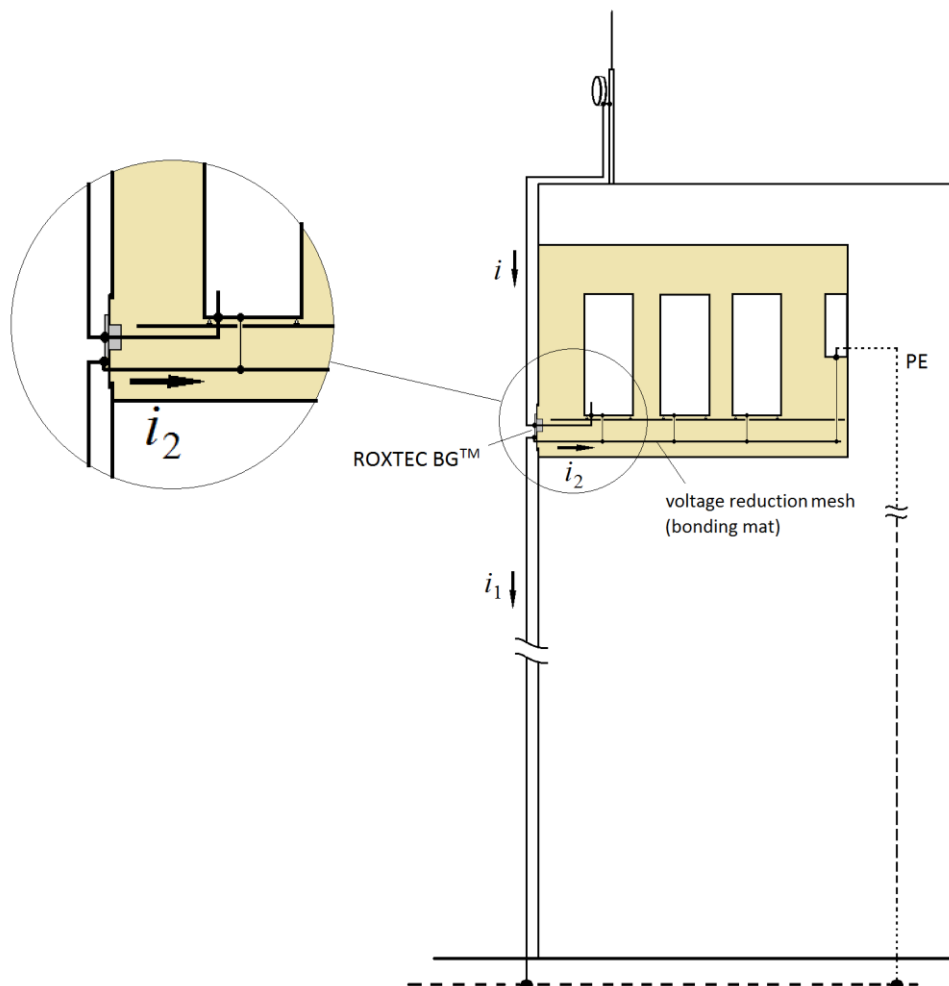

Figure 25: An equipment room near the top of a building, far from the earthing system. A ROXTEC BG™ cable transit is used to make a low impedance bonding between the antenna cables and the bonding mat under the equipment cabinets. From the same point, an earthing conductor or two conductors in parallel go downward to the earthing system.

¹⁰ The external earthing conductor will work as an additional down-conductor for the external LPS. The richer the external LPS, the lower is the current traversing the equipment room. If the steelwork of the reinforced concrete is properly used as natural down-conductor system, which is good, a bonding to the steelwork should be made as close as possible to the cable transit.

References

- [1] José Claudio O. Silva, Antônio R. Panicali; Malhas de redução de tensão para proteção de equipamentos sensíveis (*Voltage reduction meshes for the protection of sensitive equipment*); in Portuguese; NETCOM 2011; 2011.
- [2] IEC 62305-4:2010 (Ed. 2.0); Protection against lightning – Part 4: Electrical and electronic systems within structures; IEC, 2010.
- [3] IEC 62305-1:2010 (Ed. 2.0); Protection against lightning – Part 1: General principles; IEC, 2010.
- [4] IEC 60364-4-44:2007 (Ed. 2.0); *Low-voltage electrical installations; Part 4-44: Protection for safety – Protection against voltage disturbances and electromagnetic disturbances*; IEC, 2007.
- [5] ITU-T K56; *Series K: Protection against interference – Protection of radio base stations against lightning discharges*; ITU, 2010.
- [6] ROXTEC; ROXTEC BG™ B/BG™ *sealing solutions – Description and application guidelines*; 2014.
- [7] IEC 61000-4-5:2005 (Ed. 2); *Electromagnetic compatibility (EMC) – Part 4-5: Testing and measurement techniques – Surge immunity test*; IEC, 2015.
- [8] IEC 61000-4-4:2012 (Ed. 3); *Electromagnetic compatibility (EMC) – Part 4-4: Testing and measurement techniques – Electrical fast transients/bursts immunity test*; IEC, 2012.
- [9] IEC 60364-4-41:2005 (Ed. 5.0); *Low-voltage electrical installations; Part 4-41: Protection for safety – Protection against electric shock*; IEC, 2005.
- [10] IEC 60364-5-54:2011 (Ed. 3.0); *Low-voltage electrical installations; Part 5-54: Selection and erection of electrical equipment – Earthing arrangements and protective conductors*; IEC, 2011.

Test lab

Laboratório de Proteção Elétrica da
Fundação CPqD; Campinas – SP, Brazil.

Photo on first page

Courtesy of ELAT/INPE
Project P1P2 - CST/INPE
Date: 15/01/2014 20:58 h
Place: São Paulo – SP, Brazil
Camera Nikon D800
Original photo with 24 mega pixels
300 × 300 dpi
f/8
Exposition time 18.3 s
ISO-100

Acknowledgements

The author would like to express his gratitude to those whose contribution, in various ways, improved the quality of this work or even made it possible:

Celio Fonseca Barbosa and Antero Antunes Silva Júnior (Fundação CPqD), Antonio Roberto Panicali (PROELCO), Marcelo Saba (ELAT/INPE), Bo Millevik (ROXTEC, Sweden), and to Bruno Galhardo, Marcio Linhares, Rodrigo Cabral Ribeiro da Silva and Marcelo Campos (ROXTEC LATIN AMÉRICA LTDA), for the interest, participation and support to the realization of the tests.

claudio.silva@aptemc.com.br
www.aptemc.com.br